

MANUAL



OV03(T)

Introduction

Please read this manual before using the product in order to give you the necessary product and installation instructions to assure a seamless installation and non-compromised overall sound quality.

Thanks for purchasing our APart OVO3(T) speaker. Budget and quality sound united: welcome the OVO-speakers. This series of cabinet speakers fits into any decor or interior style. The OVO3(T) can be used in Lo-Z systems. The T version features a 100 Volt transformer and a Lo-Z impedance of 16 ohms and 3 power settings at 100 Volt: 1.5, 3 and 6 watts. The OVO3(T) uses a new bracket system that allows you to position the speaker in a variety of different angles. In case you want to place your OVO on a flat surface, you can use the supplied pad. The sturdy ABS plastic housing guarantees years of trouble free musical enjoyment. Affordable, but by no means a compromise on sound quality – Typically APart!

Safety precaution

- Keep this manual for future reference.
- Take care of your speaker wires, they should be free of damage. Damaged speaker wires may result in poor sound quality and can damage amplifiers.
- Only use accessories specified by the manufacturer.
- Make sure the ceiling or wall construction can support the speaker's weight.
- Use a sufficient amount of speakers to avoid death-spots.
- No main power shall be connected to the loudspeakers. Doing so will damage the speaker.
- This apparatus should only be serviced by qualified personnel. If not, warranty might be void.
- The speaker grille is fixed, removing it can damage it.
- Use cable of the right gauge, certainly for long runs.
- Use cables with clear color indication and maintain polarity throughout the whole system.

- Avoid loud feedback from microphones, this can damage your speaker.
- Please check the packing for any kind of damage upon reception of the goods. If the packing is damaged, please contact your dealer before opening it.
- Please note that the speaker must be protected from rain.

Features and benefits

- Inconspicuous and elegant design
- Remarkable sound quality and extremely affordable.
- 3 inch coated paper woofer and 1 inch silk dome tweeter.
- 40 Watts program power at 16 Ohm.
- 6 – 3 – 1.5 Watts easily selectable 100 V transformer.
- ABS plastic housing
- Useable for both 100 V and low impedance systems.
- Mounting bracket that allows tilting and turning.
- Free stand pad for usage on flat surfaces like desks.
- Quick fit cable clamps for quick and easy mounting.
- Indoor use only
- Can be painted in any RAL color from a minimum of 12pieces. (ref.: PAINTCAB6)

Connecting the speaker

Use the correct polarity when daisy chaining speakers! When a mistake occurs in your daisy chain, it may have a severe impact on speaker performance as there will be audio-cancellation.

The daisy chain options are endless and the setup will depend on the capabilities of your amplifier. When daisy chaining speakers make sure that the total impedance is not lower than the lowest specified impedance of your amplifier. Not following this rule may result in distorted sound and may even damage your amplifier. Always check daisy chains with a dedicated impedance meter.

Series wiring speaker diagram:

Total impedance = $Z1 + Z2 + Z3 + Z4 + \dots$

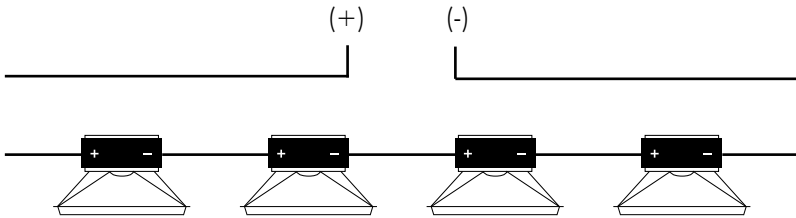

Parallel wiring speaker diagram:

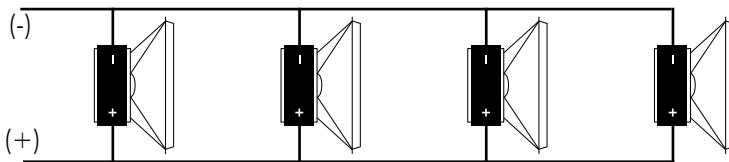

Total impedance = $\frac{1}{1/Z1 + 1/Z2 + 1/Z3 + 1/Z4 + \dots}$

$Z1$ = impedance of speaker 1

$Z2$ = impedance of speaker 2

$Z3$ = impedance of speaker 3

$Z4$ = impedance of speaker 4

...

100V technology

70 Watt ≥ 20W+ 20W+ 10W+ 5W + 5W + 5W + 2.5W + 2.5W

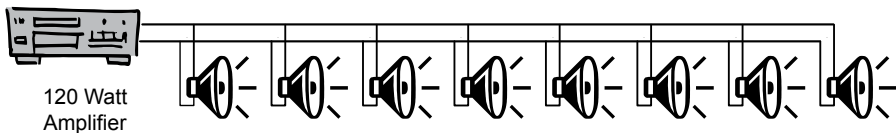

Amplifier power must be equal or higher than the total power of all speakers. In 100 volt systems, all speakers are connected in parallel.

Specifications

Woofer	3 inch coated paper
Tweeter	1 inch silk dome tweeter
Music power RMS	40W / 8 or 16 Ohm
100 volt power settings	1.5 – 3 – 6 watts (T version only)
Frequency response	90 Hz to 20 kHz
SPL 1W / 1m	86dB
SPL 1m / max rated power	102dB
Dispersion at 1kHz, 4kHz, 8kHz	180°, 120°, 80°
Color	white or black
Cabinet material	ABS
Grille material	Steel
IP class	60
Fixing type	mounting bracket or table stand
Height (mm)	160mm
Width (mm)	110mm

Depth (mm)	117 mm (160 mm including bracket)
Distance from wall	43 mm
Net weight (pair)	1.7 kg (2.1 kg T version)
Gross weight (pair)	1.9 kg (2.3 kg T version)

Polar diagram 1000 Hz

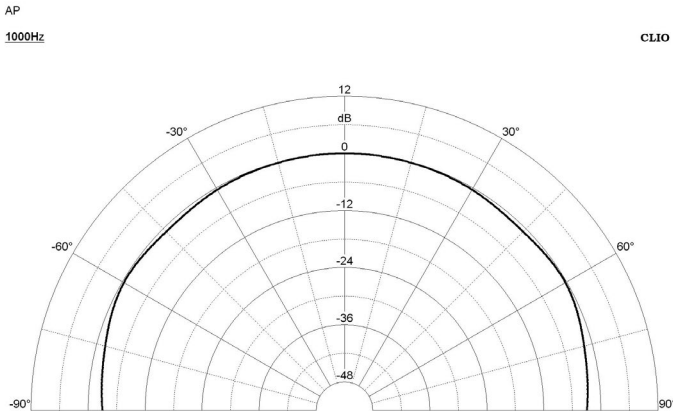

Polar diagram 4000 Hz

AP

4000Hz

C.LIO

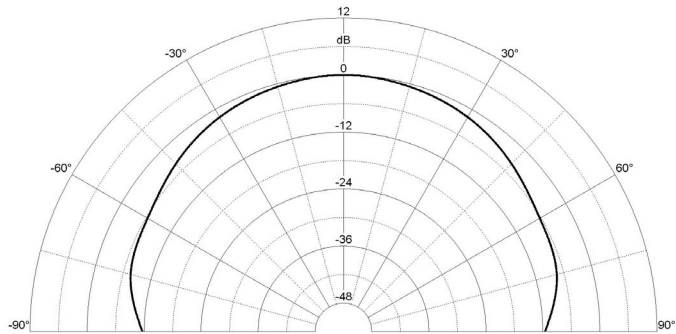

Polar diagram 8000 Hz

AP

8000Hz

C.LIO

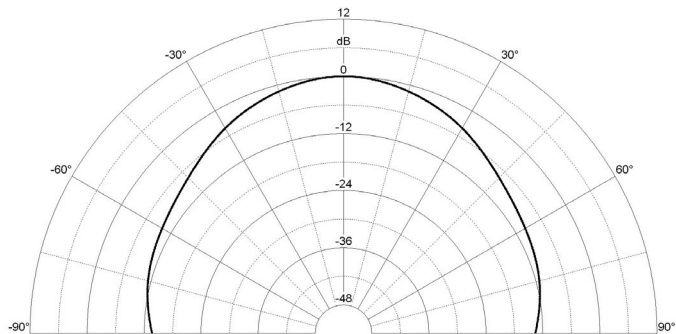

Technical drawing with measurements

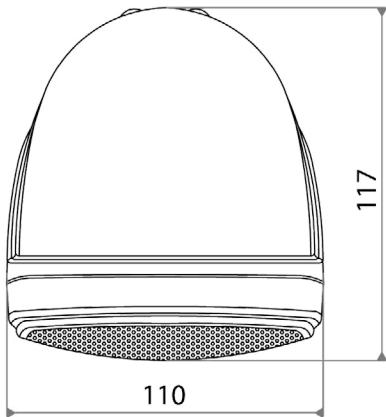
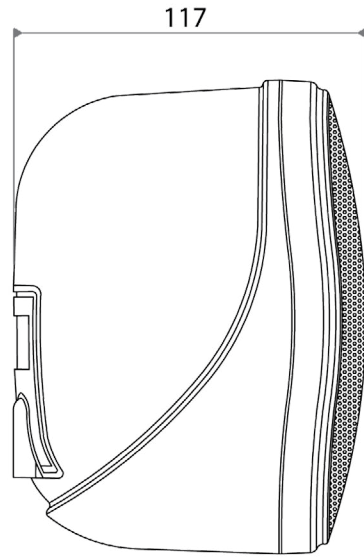
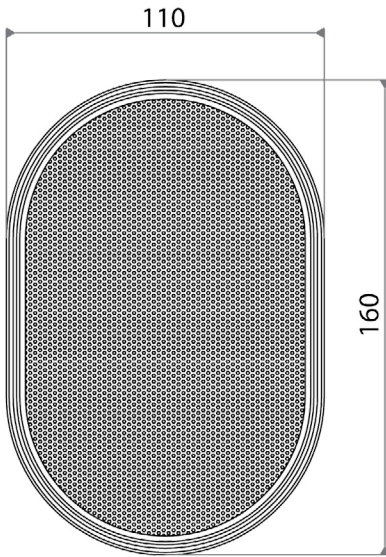

Warranty info

APart-Audio warrants this product to be free of defects in material and workmanship for a period of one year for parts and for a period of one year for labor from the date of original end-user purchase. This warranty is valid only for the original end-user and cannot be transferred.

During the warranty period APart-Audio or one of its authorized service partners shall either repair or replace any product, free of charge, which proves to be defective upon inspection by APart-Audio or its authorized service representative. This warranty does not include, damages or product faults due to abuse, misuse or faulty installation.

Company names, product names, and names of formats etc. are the trademarks or registered trademarks of their respective owners.

© 2011 APart-Audio specifications subject to change without notice.

developed by

*Audioprof nv
Industriepark Brechtsebaan 8 bus 1
2900 Schoten
Belgium*

